

	組	番	名前	
--	---	---	----	--

⑧ ^{なが}長さ(1) (長さの ^{かた}あらわし方)

1 長さは どれだけでしょうか。

①

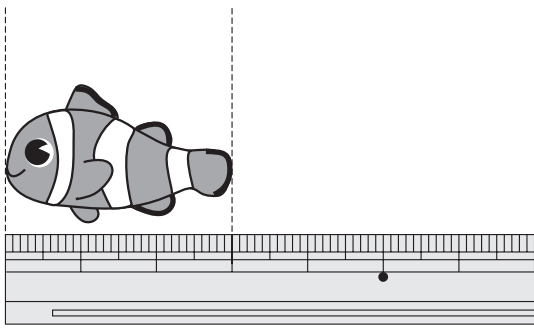

() cm

②

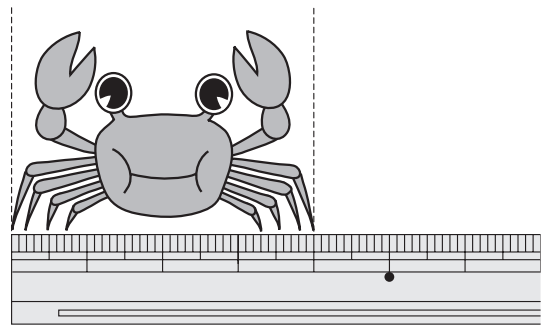



() cm

2 れんしゅうを しましょう。

_____ cm cm

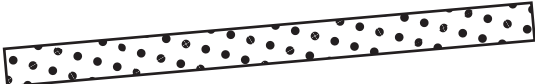
3 テープの 長さを はかりましょう。

①  (cm)

②  (cm)

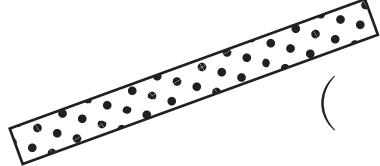
③  (cm)



4 テープの 長さを はかりましょう。

①  (cm)

②  (cm)

③  (cm)

ひとつだけ ぬりましょう。

		
やさしかった	ふつう	むずかしかった